

Article number: 20146B35562SW

Description: E+G
Flanged Connector GN 146-B35-56-2-SW

Measures

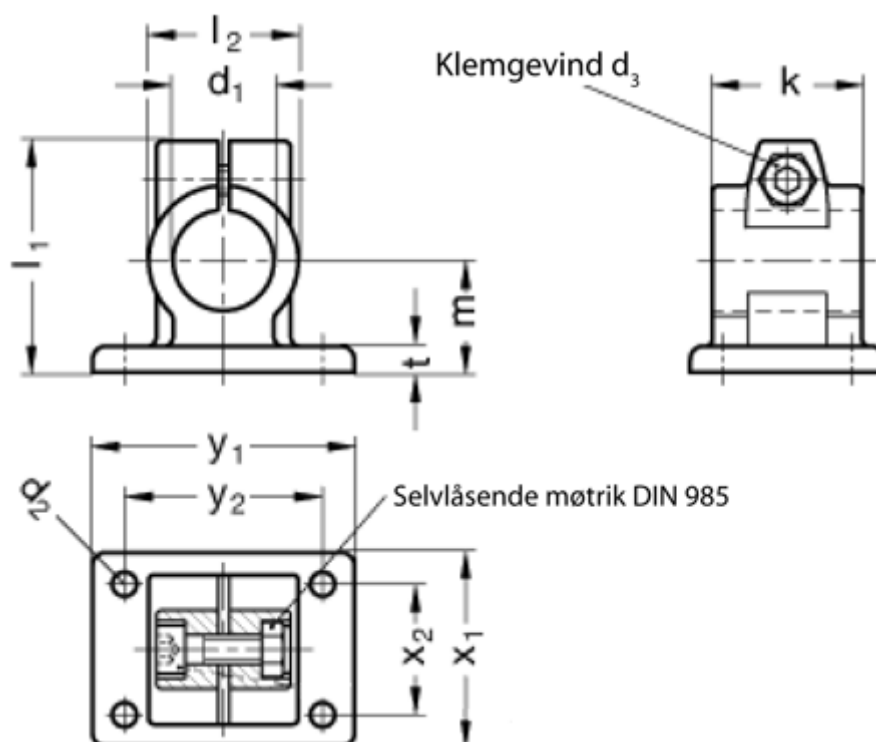

Adjustable clamp lever = GN 911-M10-40 have to be ordred separately

d1 = B35
d2 = 8.5
d3 = M10
k = 56
l1 = 83
l2 = 56
m = 42

t = 10
x1 = 78
x2 = 52
y1 = 108
y2 = 82